

MODELS-631, 632, 633, 634



All stainless steel construction Pressure Gauges

APPLICATIONS

600 series gauges are suitable for corrosive environments and gaseous or Liquid media that will not obstruct the pressure system in chemical, Petro-chemical, refining, power, marine, food and pharmaceutical Processing applications, on and offshore.

STANDARD SPECIFICATION

Petro-Chemical Gauge with Blow-out Device (Weatherproof Construction to IP66)

Sizes

63, 100 and 150 mm

Case/ Bezel

316 Stainless Steel

Socket & Element

316 Stainless Steel

Movement

Stainless Steel Construction

Blowout Protection

Blow-out plug at the top of the case

Dial

White Anodised Aluminium (Black Printing)

Pointer

Black Aluminium

Window

Sheet Glass

Traceability

All instruments are individually calibrated and have an unique Serial Number.

Certification available on request

- Certificate of Conformity Traceable to National Standards
- Group Certification (Pressure Test Calibration Statement)
- Point to Point Test Certificate
- BS EN 10204 3.1 Material Certification

Safety

All units are manufactured to comply with EN 837-1, S1 Blowout device specification and other regulatory standards including PED 2014/68/EU.

Installation instructions

Refer to EN 837-2 and our [Guidance On Use of Equipment](#) data sheet.

Accuracy class

	ACCURACY CLASS EN837-1 (Optional)		Higher Pressure
	0 - 600 bar	>600 - 1600 bar	>1600 - 2500 bar
63mm	1.0	1.6 *	N/A
100mm	1.0 (0.6)	1.0	1.6
150mm	1.0 (0.6)	1.0	1.6

0.5% Accuracy on request (Consult Sales)

Higher Ranges on request (Consult Sales)

Over-pressure

0 - 100 bar	>100 - 600 bar	>600 - 1600 bar	>1600 - 2500 bar
1.25 x FSD	1.15 x FSD	1.10 x FSD	1.10 x FSD

Scale Range

Vacuum / Compound to -1 to 0 to -1 to 24 bar

63mm gauge 0 to 1400 bar *

100 & 150mm gauges 0 to 2500 bar

Or other equivalent units of pressure or vacuum

PED 2014/68/EU, GAS Group.1 <1000 bar, GAS Group.2 <3000 bar

Pressure Connection Thread

1/8", 1/4", 3/8", 1/2" NPT, BSP, BSPT (See High Pressure Options)

MAX PRESSURE EN 837-1			
THREAD EN837	NPT (316ss / Monel)	BSP (316ss / Monel)	BSPT (316ss / Monel)
1/8"	400 bar	400 bar	400 bar
1/4"	1000 bar	1000 bar	1000 bar
3/8"	1000 bar	1000 bar	1000 bar
1/2"	1000 bar	1600 bar	1000 bar

Dry, Liquid Fillable or Pre-Filled. VIBRAGAUGE® Option also available.

VIBRAGAUGE® for Dampening of vibration & pulsation without liquid filling.

With liquid-filled case for applications with high dynamic Pressure pulsations or vibration.

Model-632 Direct Mounted



Model-631 Surface Mounted (Bottom Connection)

Model-632 Direct Mounted (Bottom Connection)

Model-633 Flush Mounted Screw Fixing (Rear Connection)

Model-634 Flush Mounted Clamp Fixing (Rear Connection)

See Page-2 for dimension

Operating Temperature Range EN837

-20° to 60°C (-4°F to 140°F)

Options for lower/higher operating ranges (Contact Sales)

Temperature Error

Additional error when temperature changes from reference

Temperature of 20°C (68°F) ±0.4% for every 10°C (18°F) rising or Falling % of span

Optional Extras

- Micro adjustable pointer /Black finish
- Optional dial materials & Custom markings
- Monel according to ISO 15156 / NACE MR-01-75 wetted parts
- Other pressure connections (Including high pressure)
- Laminated safety glass / Perspex window
- Orifice Restrictor Screw (standard Ø0.9mm, Ø0.4mm on request)
- Customer logo printed on dial
- Liquid filled / Suitable for liquid filling
- Nitelitegage® (See data sheet)
- Vibragauge® (See data sheet)
- Snubbagauges® (See data sheet)
- Fitted with electrical contacts (See data sheet)
- Gauge over-pressure up to 130% of FSD

Further options on request

Available with a wide range of accessories

Syphons, Snubbers, Overrange gauge protectors, Valves, Manifolds, Diaphragm seals, Swivel adaptors, etc ensures that STEWARTS can provide you with the right product to suit any individual application or requirement.

High Pressure Options Available

GAUGE	HIGH PRESSURE THREAD OPTIONS (Up to 2500 bar)					
	TUBE MP (Up to 20 ksi)			TUBE HP (Up to 36 ksi)		
	1/4"	3/8"	9/16"	1/4"	3/8"	9/16"
63mm	M	M				
100mm	M/F	M/F	M	M/F	M	M
150mm	M/F	M/F	M	M/F	M	M

Ordering Parameters, Please state the following: SIZE, MODEL NO, SCALE RANGE, CONNECTION, PRESSURE MEDIUM & OPTIONAL EXTRAS

MODELS-631, 632, 633, 634

All stainless steel construction Pressure Gauges

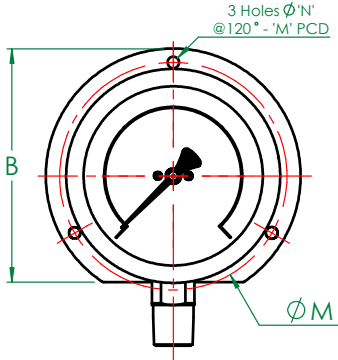

MODEL - 631
Surface Mounted

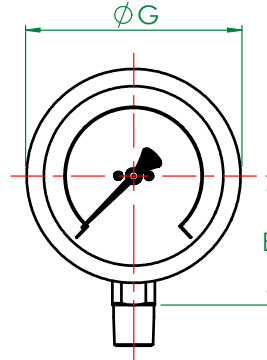
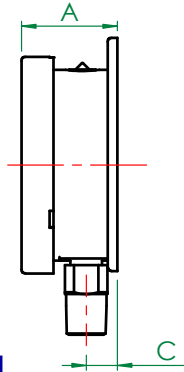

MODEL - 632
Direct Mounted (Standard)

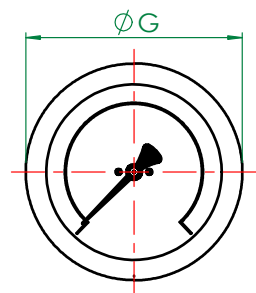
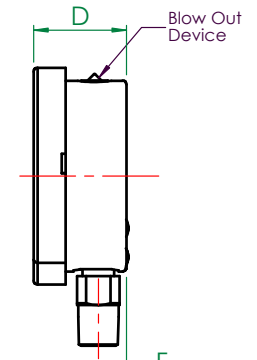

MODEL - 632-BC
Direct Mounted - Rear Connect

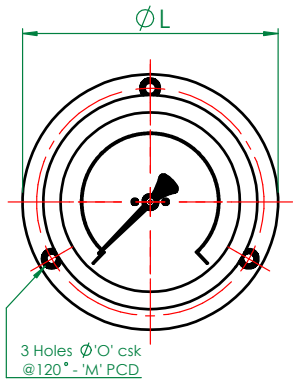
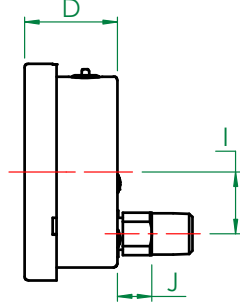

MODEL - 633
Flush Mounted - Screw Fixing

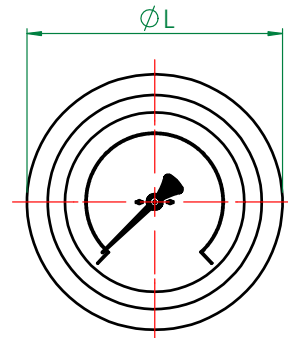
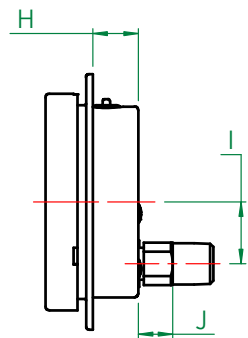

MODEL - 634
Flush Mounted - Clamp Fixing

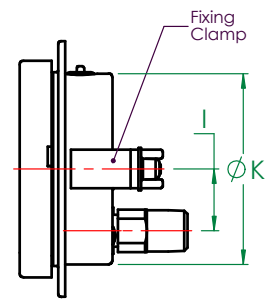

General Arrangement Dimensions in mm, tol' ± 1mm

DIM ø mm	A	B	C	D	E	F	G	H	I	J	K	L	M	N	O	CUT OUT
63 (2½")	34.5	78.5	12.5	31.5	41.8	9.5	68.4	21.5	18	13	62	85.2	75	3.5	3.8	66
100 (4")	50.7	121	16.2	49	66.9	14.5	112.2	24.5	32	18	99	132.5	118	6	6	106
150 (6")	52.7	174	18.4	49.5	92.1	15.2	161.7	24	32	17.8	148	186	168	5.8	5.8	153

STEWART-BUCHANAN GAUGES LTD

Sales Office & Manufacturing Facility - 7 Garrel Road, Burnside Industrial Estate, Kilsyth, Glasgow G65 9JX, SCOTLAND
Tel: +44 (0)1236 821533 | Fax: +44 (0)1236 824090 | E-mail: sales@stewarts-group.com | Web: stewarts-group.com

DATA SHEET REF: 63-REV01-14

